

Tempomat GDI

 = ist bereits vorhanden

 = überprüfen, ob vorhanden und vollständig verdrahtet

 = muss verlegt / eingebaut werden

TEMPOAUTOMATIK

GDI

1

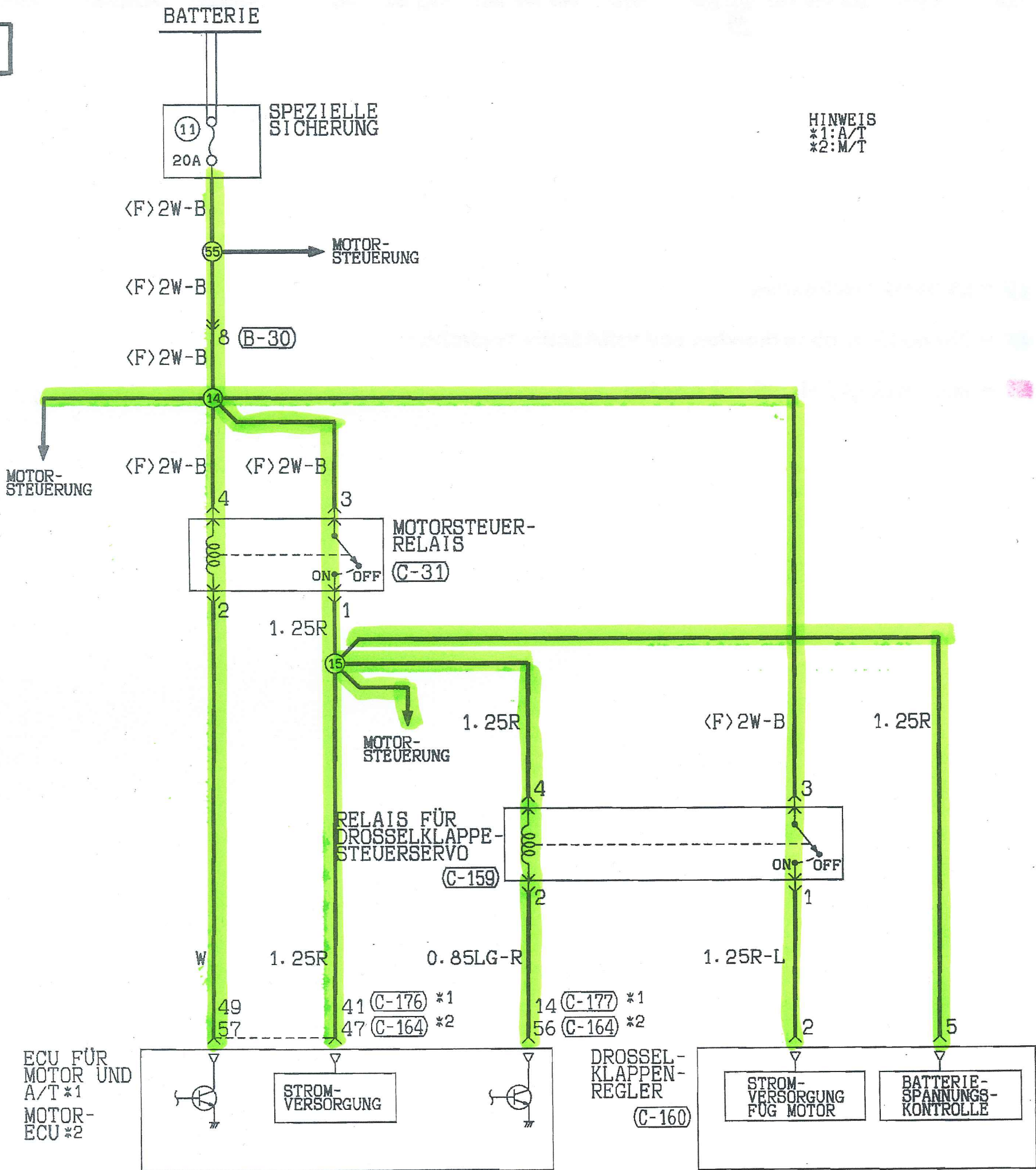

HINWEIS
*1:A/T
*2:M/T

(B-30) MU802357



(C-31) MU801560

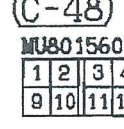

(C-48) MU801560

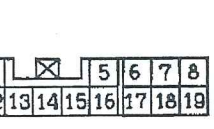

(C-63)

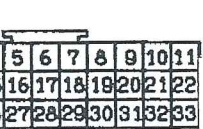

(C-65)

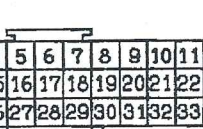

(C-66)

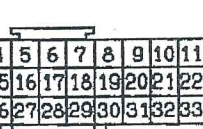

(C-141)

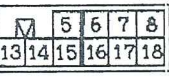

(C-159)

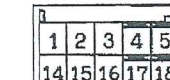

(C-160) (MU801824)

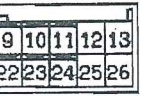

(C-164) (MU803782)

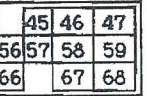

(C-176) (MU803781)



2

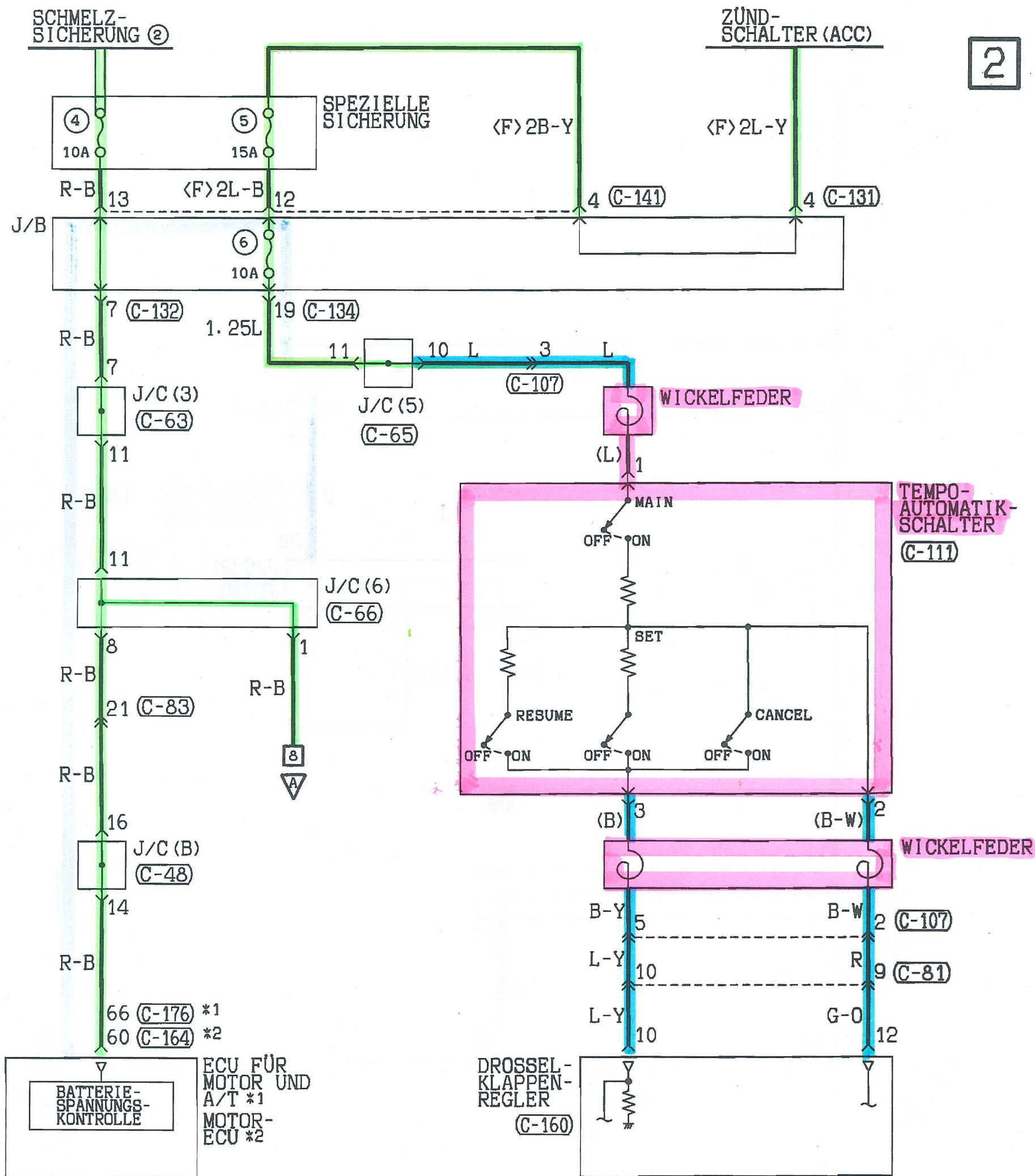

(C-81)

1	2	3	4	5	6	7	8	9	10
11	12	13	14	15	16	17	18	19	20
21	22								

(C-83)

1	2	3	4	5	6	7	8	9	10
11	12	13	14	15	16	17	18	19	20
21	22								

(C-107)

1	2	3	4	5

(C-111)

1	2	3

(C-131)

1	2
3	4
5	6

(C-132)

1	2	3	4
5	6	7	8
9	10		

(C-134)

1	2	3	4	5	6	7	8	9	10
11	12	13	14	15	16	17	18	19	20
21	22								

(C-177) (MU803784)

1	2	3	4	5	6	7	8
9	10	11	12	13	14	15	16
17	18	19	20	21	22	23	24
25	26	27	28	29	30	31	32
33	34	35					

Kabelfarbcode

B : Schwarz
BR : Braun
W : Weiß
V : Violett

LG : Hellgrün
O : Orange
SB : Himmelblau

G : Grün
GR : Grau
P : Rosa

L : Blau
R : Rot
Y : Gelb

TEMPOAUTOMATIK <GDI> (FORTSETZUNG)

3

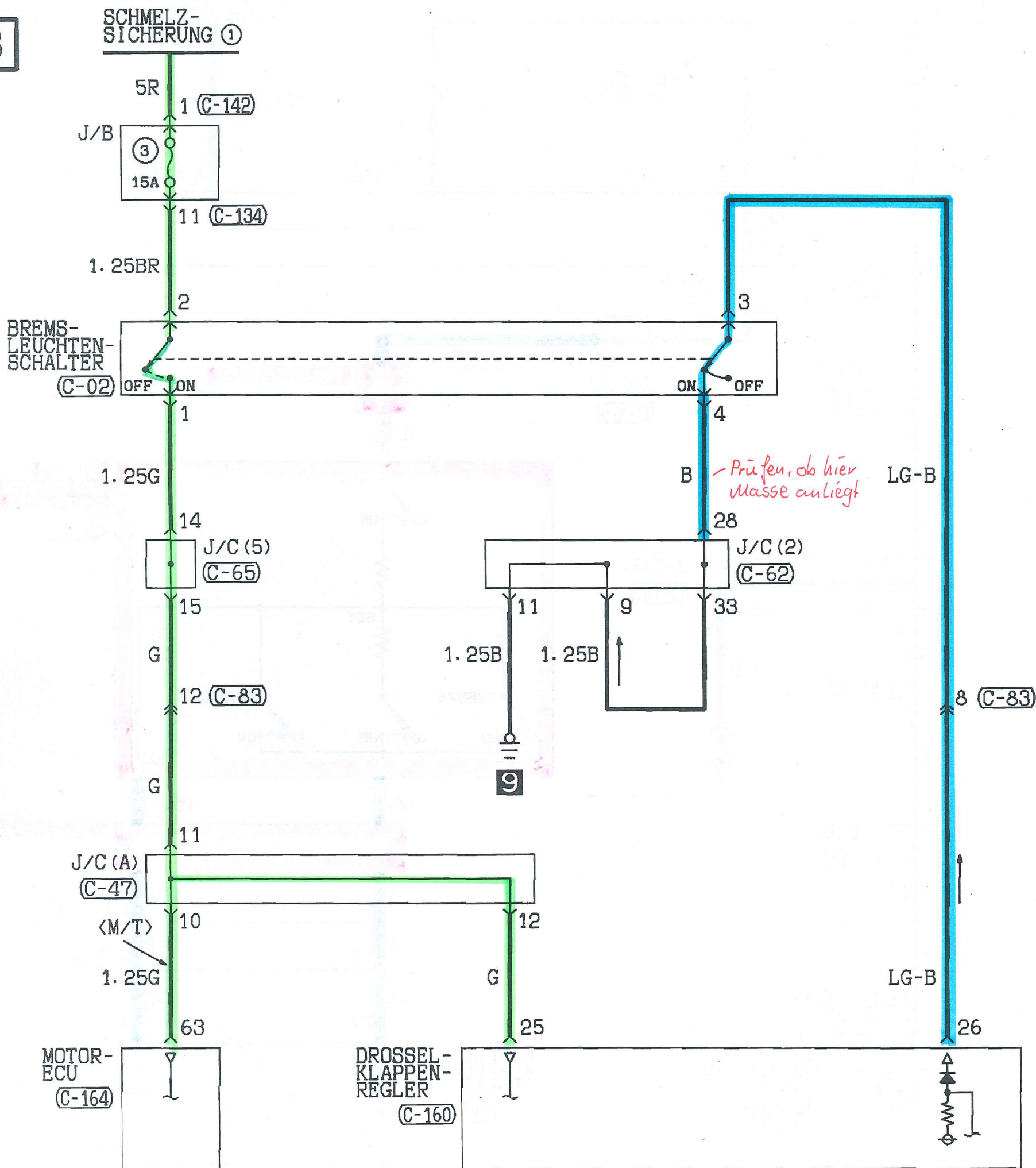

(C-02) (MU801490)

1	2
3	4

(C-47) MU801560

1	2	3	4	5	6	7	8			
9	10	11	12	13	14	15	16	17	18	19

(C-62)

1	2	3	4	5	6	7	8	9	10	11
12	13	14	15	16	17	18	19	20	21	22
23	24	25	26	27	28	29	30	31	32	33

(C-65)

1	2	3	4	5	6	7	8	9	10	11
12	13	14	15	16	17	18	19	20	21	22
23	24	25	26	27	28	29	30	31	32	33

(C-83) MU801461

1	2	3	4	5	6	7	8	9	10		
11	12	13	14	15	16	17	18	19	20	21	22

(C-164)

41	42	43	44	45	46	47					
48	49	50	51	52	53	54	55	56	57	58	59
60	61	62	63	64	65	66	67	68			

(C-165) (MU803784)

1	2	3	4	5	6	7	8							
9	10	11	12	13	14	15	16	17	18	19	20	21	22	23
24	25	26	27	28	29	30	31	32	33	34	35			

(C-177) (MU803784)

1	2	3	4	5	6	7	8							
9	10	11	12	13	14	15	16	17	18	19	20	21	22	23
24	25	26	27	28	29	30	31	32	33	34	35			

(D-01)

41	42	43	44	45	46	47	48
49							
50	51	52	53	54	55	56	57

4

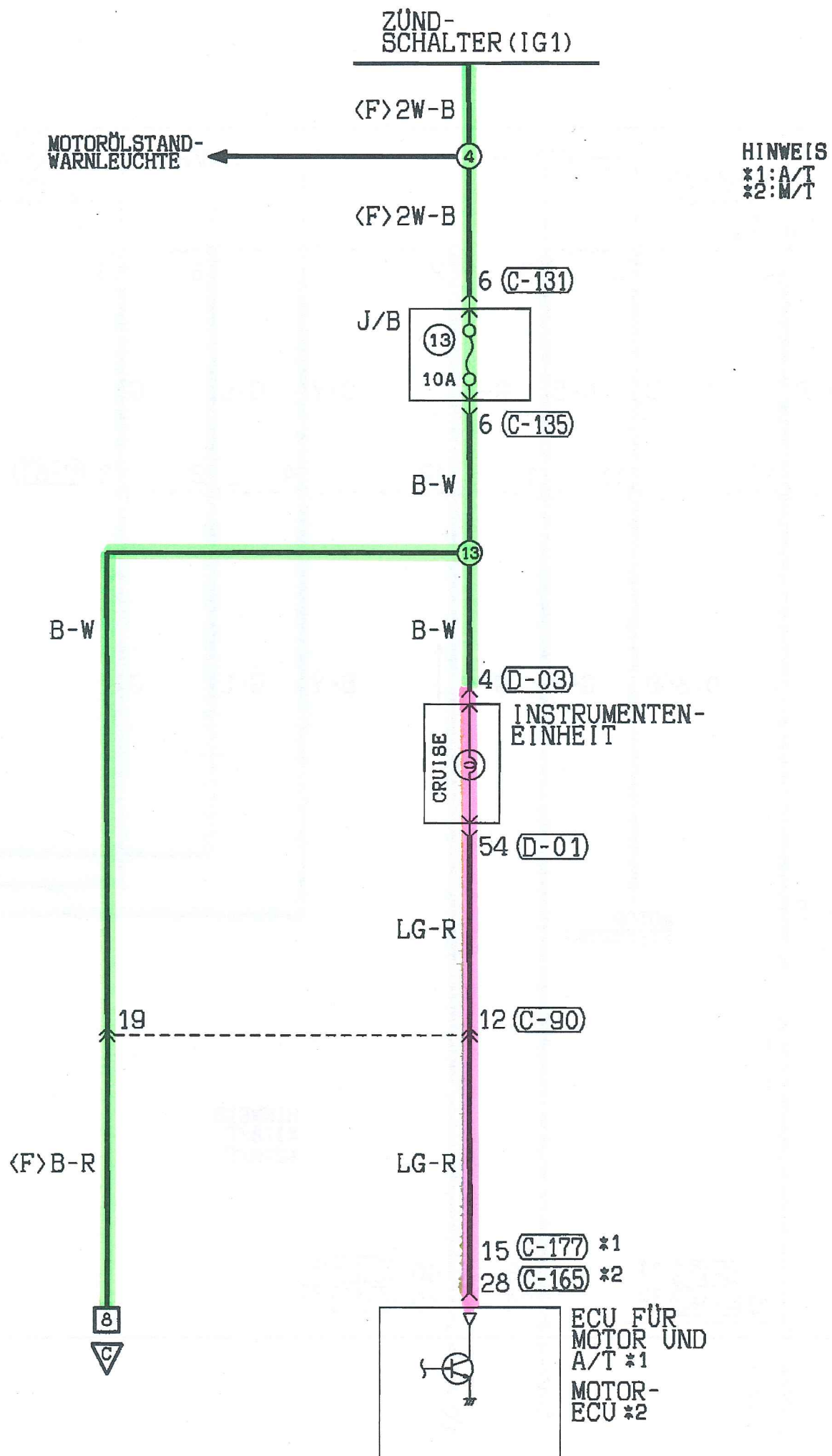

(C-90)
MU801457

1	2	3	4	M	5	6	7	8	9	
10	11	12	13	14	15	16	17	18	19	20

(C-131)
MU801331

1	2		
3	4	5	6

(C-134)

1	2	3	4	5	M	6	7	8	9	10	
11	12	13	14	15	16	17	18	19	20	21	22

(C-135)
MU801457

1	2	3	4	M	5	6	7	8	9	
10	11	12	13	14	15	16	17	18	19	20

(C-142)

1

(C-160) (MU801824)

1	2	3	4	5	6	7	8	9	10	11	12	13
14	15	16	17	18	19	20	21	22	23	24	25	26

(D-03)

1	2	3	4	5	6	7	8
9							
10	11	12	13	14	15	16	17

Kabelfarbcode
 B : Schwarz LG: Hellgrün G : Grün L : Blau
 BR: Braun O : Orange GR: Grau R : Rot
 W : Weiß SB: Himmelblau P : Rosa Y : Gelb
 V : Violett

TEMPOAUTOMATIK <GDI> (FORTSETZUNG)

5

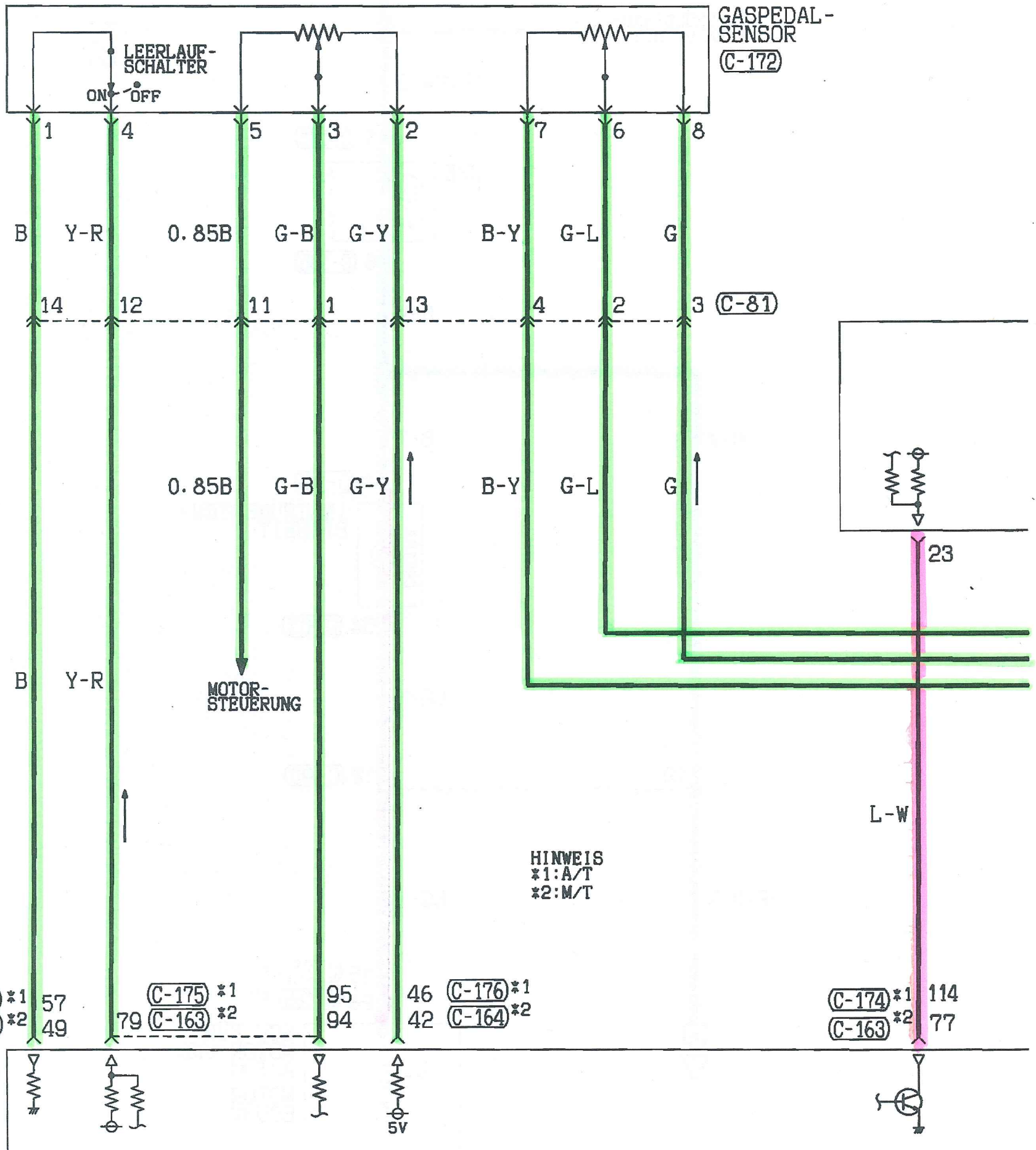

(B-07) (MU802724)

1	2	3	4
---	---	---	---

(B-97)

1	2	3	4
---	---	---	---

(C-45) (MU801336)

1	2	3	4
5	6	7	8
9	10		

(C-81)

1	2	3	4	5	6	7	8	9	10
11	12	13	14	15	16	17	18	19	20
21	22								

(C-160) (MU801824)

1	2	3	4	5	6	7	8	9	10	11	12	13
14	15	16	17	18	19	20	21	22	23	24	25	26

(C-163) (MU803783)

71	72	73	74			75	76	77				
78	79	80	81	82	83	84	85	86	87	88	89	90
91	92	93	94	95	96	97	98	99	100			

(C-177) (MU803784)

1	2	3	4		5	6	7	8						
9	10	11	12	13	14	15	16	17	18	19	20	21	22	23
24	25	26	27	28	29	30	31	32	33	34	35			

6

100%

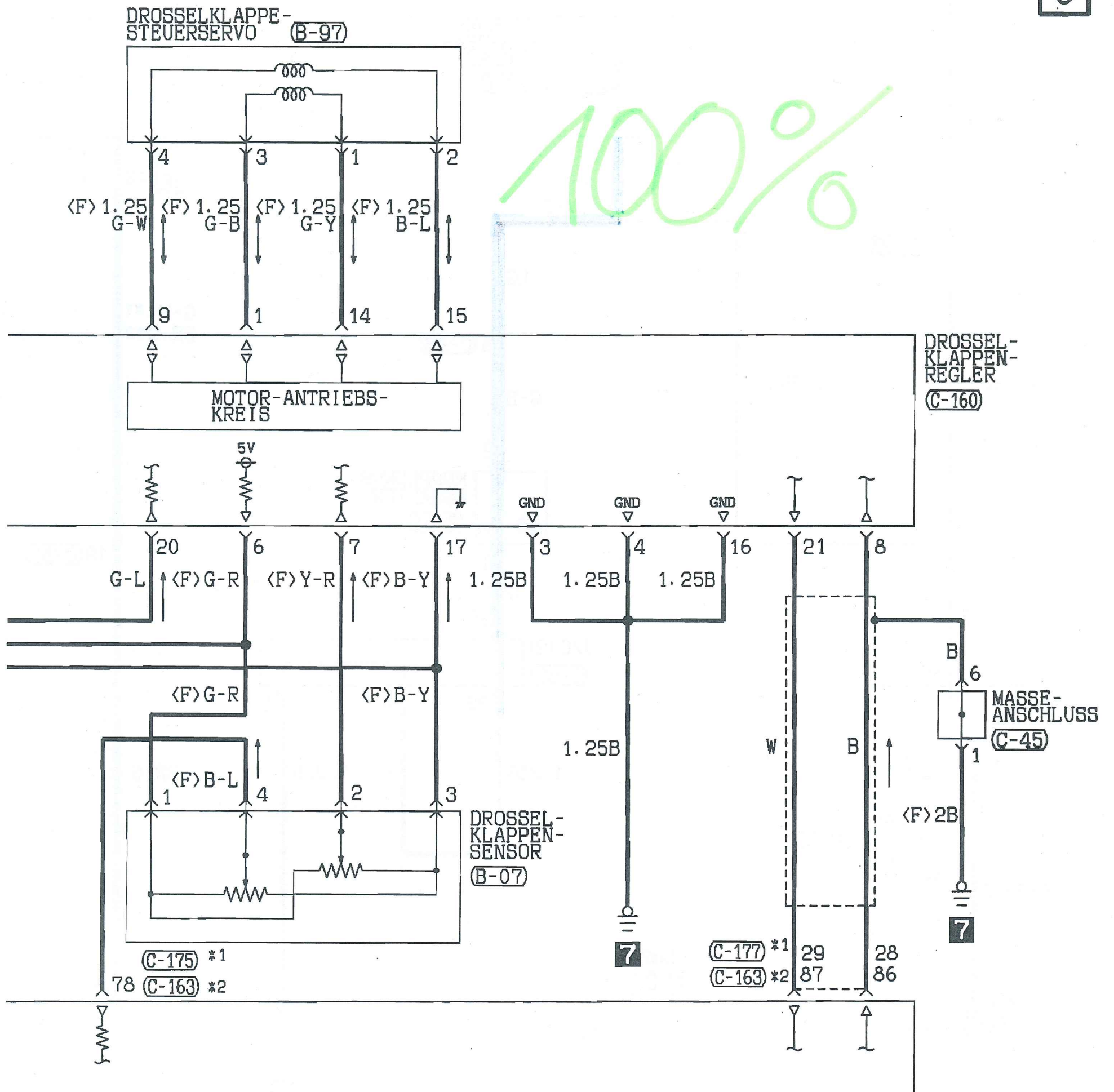

(C-164) (MU803782)

41	42	43	44		45	46	47				
48	49	50	51	52	53	54	55	56	57	58	59
60	61	62	63	64	65	66	67	68			

(C-172) (MU802073)



(C-174) (MU803783)

101	102	103	104		105	106	107					
108	109	110	111	112	113	114	115	116	117	118	119	120
121	122	123	124	125	126	127	128	129	130			

(C-175) (MU803782)

71	72	73	74		75	76	77				
78	79	80	81	82	83	84	85	86	87	88	89
90	91	92	93	94	95	96	97	98			

(C-176) (MU803781)

41	42	43			44	45	46				
47	48	49	50	51	52	53	54	55	56	57	
58	59	60	61	62	63	64	65	66			

Kabelfarbcodex
 B : Schwarz LG: Hellgrün G : Grün L: Blau W : Weiß Y : Gelb SB: Himmelblau
 BR: Braun O : Orange GR: Grau R: Rot P : Rosa V : Violett

TEMPOAUTOMATIK <GDI> (FORTSETZUNG)

7

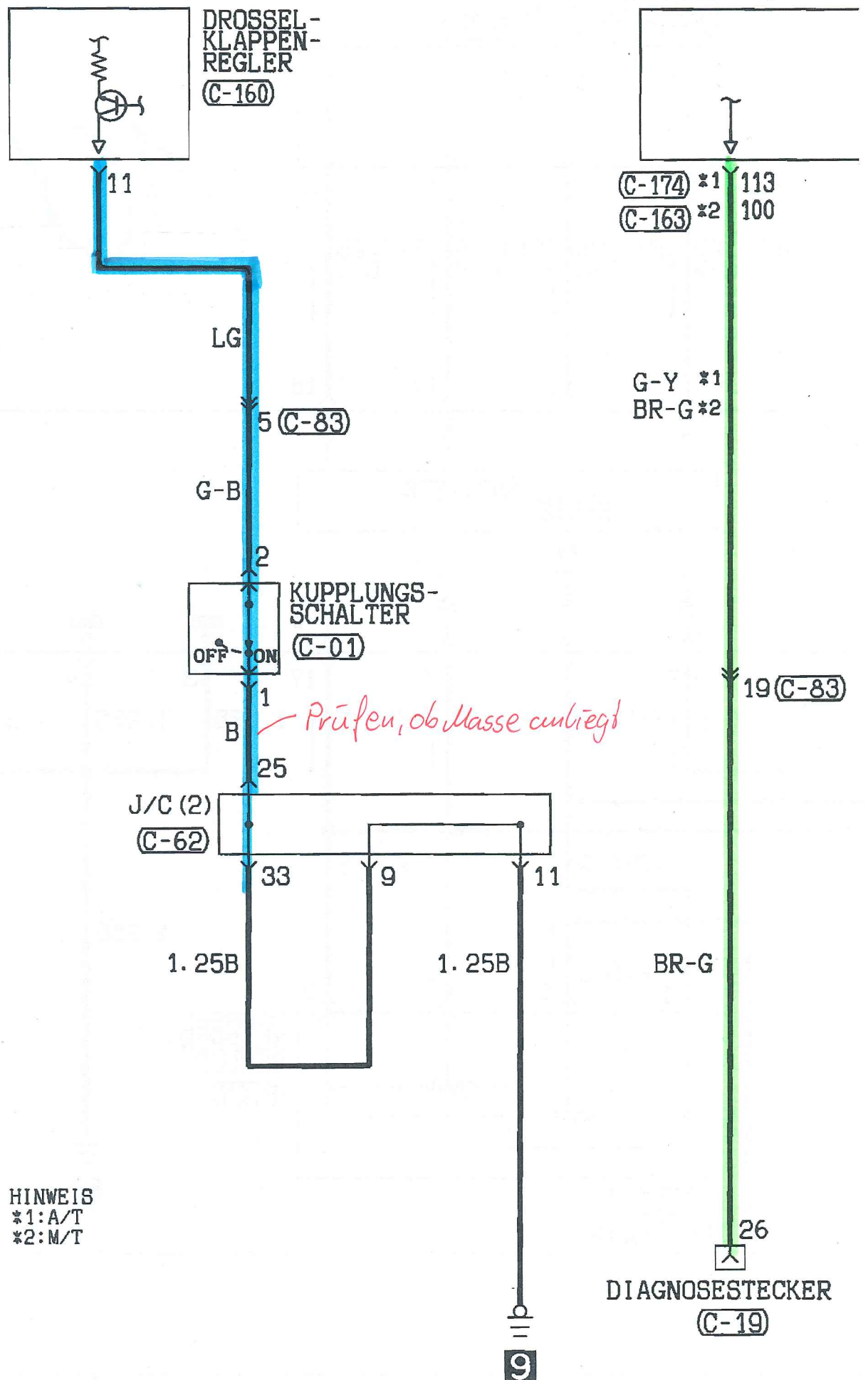

HINWEIS
*1: A/T
*2: M/T

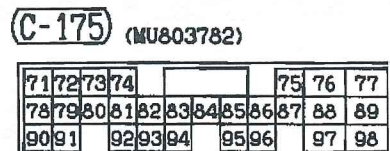
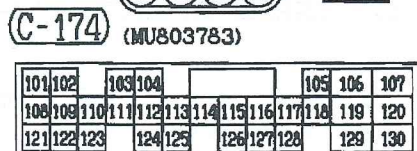
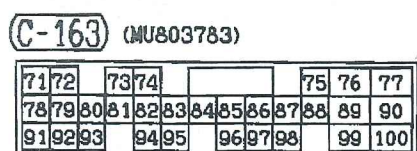
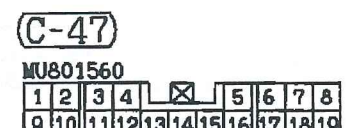
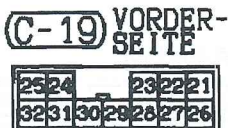
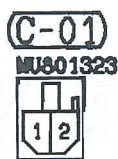
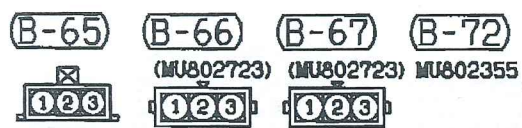

100%

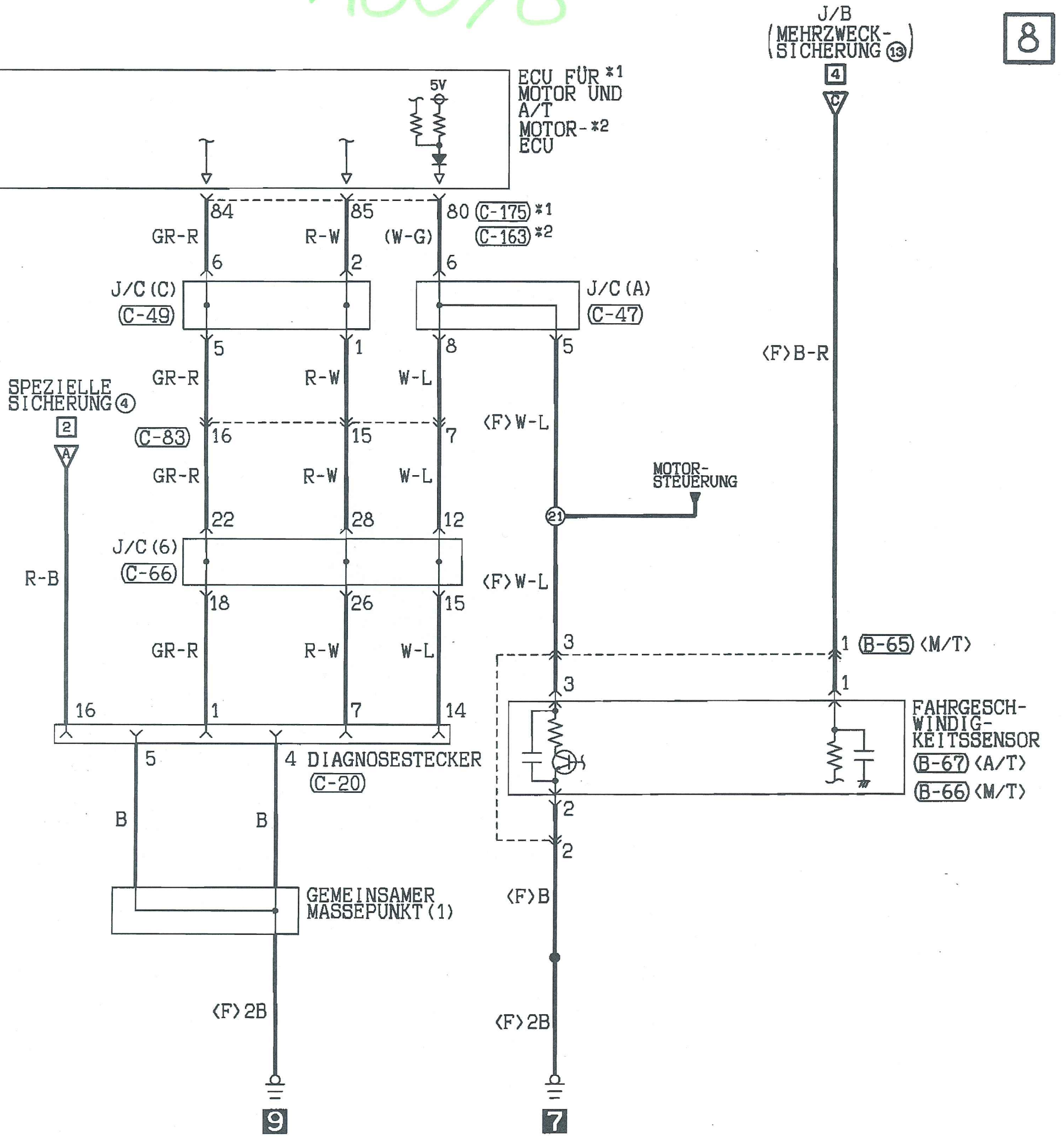

8

(C-49)

MU801560

1	2	3	4	5	6	7	8
9	10	11	12	13	14	15	16
17	18	19					

(C-62)

1	2	3	4	5	6	7	8	9	10	11
12	13	14	15	16	17	18	19	20	21	22
23	24	25	26	27	28	29	30	31	32	33

(C-66)

1	2	3	4	5	6	7	8	9	10	11
12	13	14	15	16	17	18	19	20	21	22
23	24	25	26	27	28	29	30	31	32	33

(C-83)

MU801461

1	2	3	4	5	6	7	8	9	10
11	12	13	14	15	16	17	18	19	20
21	22								

(C-92)

MU801329

1	2
3	4

(C-160)

MU801624

1	2	3	4	5	6	7	8	9	10	11	12	13
14	15	16	17	18	19	20	21	22	23	24	25	26

Kabelfarbcode
 B :Schwarz LG:Hellgrün G :Grün L:Blau W :Weiß Y :Gelb
 BR: Braun O :Orange GR:Grau R:Rot P :Rosa V :Violett

SB:Himmelblau